



# INSTRUCTION MANUAL

Eat well, drink well and live well with Omega

[www.omegajucers.com](http://www.omegajucers.com)

## 8007/8008 NUTRITION CENTER



English, Aug 2013

PLEASE READ THESE INSTRUCTIONS CAREFULLY BEFORE USE

# IMPORTANT SAFEGUARDS

**When using electrical appliances, basic safety precautions should always be followed, including the following:**

1. Read all the instructions before using the juicer.
2. To protect against risk of electrical shock, do not put the motor base in water or other liquid.
3. Close supervision is necessary when any appliance is used by or near children.
4. Unplug from outlet when not in use, before putting on or taking off parts before cleaning
5. Avoid contact with moving parts.
6. DO NOT operate any appliances with a damaged cord or plug or after the appliance malfunctions, or is dropped or damaged in any manner.
7. Return appliance to the nearest authorized service facility for examination, repair or electrical adjustment.
8. The use of attachments not recommended or sold by the manufacturer may cause fire, electric shock or injury.
9. DO NOT use outdoors.
10. DO NOT let cord hang over edge of table, counter or touch hot surfaces.
11. DO NOT place on or near a hot gas, electric burner or in a heated oven.
12. DO NOT use appliance for other than intended use.
13. Be sure to switch to off position after each use of your juicer.
14. DO NOT put your fingers or other objects into the juicer opening while it is in operation. If food becomes lodged in the opening, use the plunger or another piece of fruit to push it down. When this method is not possible, turn the motor off and disassemble juicer to remove the remaining food.
15. DO NOT plug in until familiar with all the instructions and operating procedures.
16. DO NOT unplug from electrical outlet by pulling on the cord. To unplug, grasp the plug, not the cord and pull.
17. Turn off all controls before unplugging from or plugging into an electrical outlet.

**WARNING:** This appliance has a polarized plug (one blade is wider than the other). To reduce the risk of electrical shock, this plug will fit in a polarized outlet only one way. If plug does not fit fully into the outlet, reverse the plug. If it still does not fit, contact a qualified electrician. DO NOT attempt to modify the plug in any way.

**SAVE THESE INSTRUCTIONS**

## OMEGA MODEL 8007/8008 NUTRITION SYSTEM

**This heavy-duty juicer features a patented, stone mill-like auger, made of hygienic U.S. FDA-approved melamine.**

The Omega 8007/8008 Nutrition System's low speed of 80 RPMs ensures full taste and the highest nutritional value.

The Omega 8007/8008 Nutrition System is easy to assemble and disassemble for quick cleaning.

The Omega 8007/8008 Nutrition System assures you many years of trouble-free, dependable service. Ten-year warranty on all parts and labor.

### MULTI-PURPOSE JUICER/FOOD PROCESSOR

- **FRUIT JUICE EXTRACTOR**  
efficiently juices hard and soft fruits: even citrus fruits, usually one of the hardest fruits to juice.
- **VEGETABLE JUICE**  
juices all kinds of vegetables including carrots, beets, celery, peppers, and radishes without destroying the natural flavor and nutrition benefits. Fresh taste and full nutrition are guaranteed with this unique extraction process.
- **WHEATGRASS AND LEAFY GREENS**  
Wheatgrass, kale, cabbage, spinach and pine tree needles are just some of the natural products that can be juiced with the Omega 8007/8008 Nutrition System. Enjoy the best that nature offers in raw foods of all kinds and juice them for full nutritional benefits.
- **FOOD PROCESSOR**  
chops and minces, providing natural flavor and nutrition from garlic, scallions, red pepper, ginger, and most other foods, including herbs and seasonings. Soft foods for special diets for babies are quick and easy to prepare with mincing set-up.
- **PASTA EXTRUDER**  
Homemade spaghetti, linguini, or breadsticks can be extruded in just minutes with the included pasta nozzles.
- **HOMOGENIZER**  
Makes fresh frozen desserts, natural baby food, and nut butters using your fresh fruit and vegetables.
- **GRINDER**  
Grind coffee beans and flour.

## **SPECIFICATIONS**

<b>Model Name</b>	Omega 8007/8008 Nutrition System
<b>Dimensions</b>	Height: 15 1/2" Width: 6 1/2" Length: 14 1/2"
<b>Weight</b>	13 lbs.
<b>Voltage</b>	120V/60Hz
<b>Motor</b>	2 HP single phase induction
<b>Auger RPM</b>	75 to 85

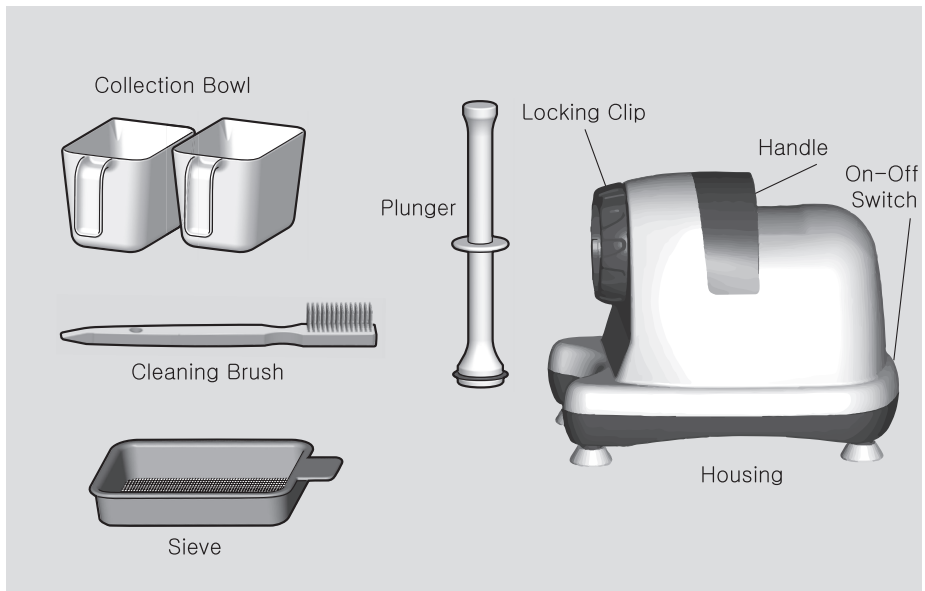

## Parts for Juicing or Mincing

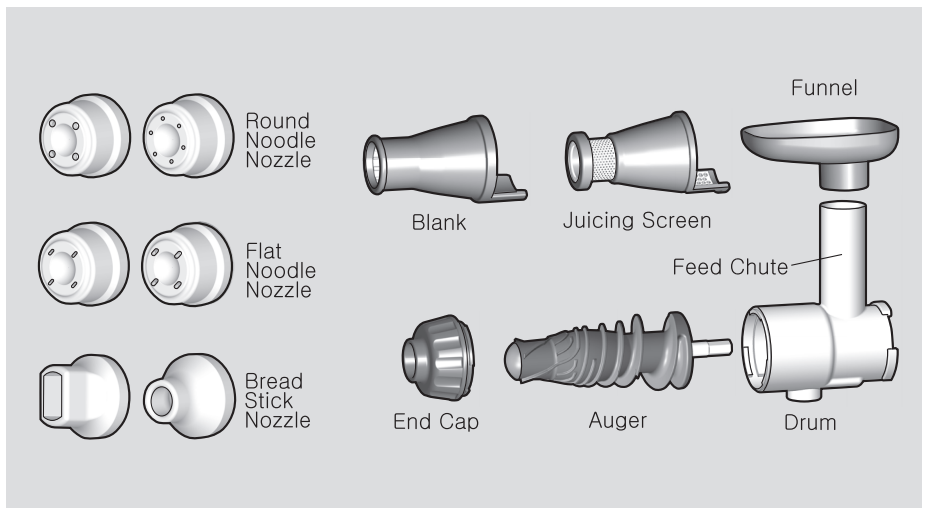

## Switch Operation Mode

- I appliance is ON
- appliance is OFF
- II appliance will REVERSE auger.  
(use when food is blocking or stuck)

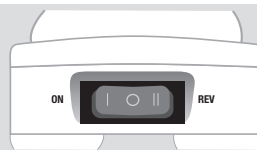

## Assembly Instructions

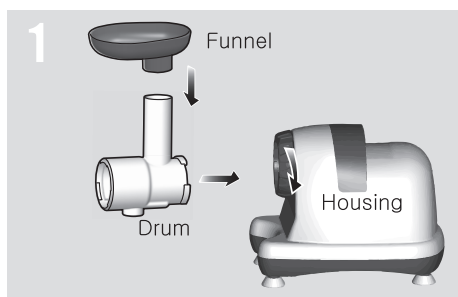

Connect drum with housing by turning locking clip clockwise. Place funnel onto guide.

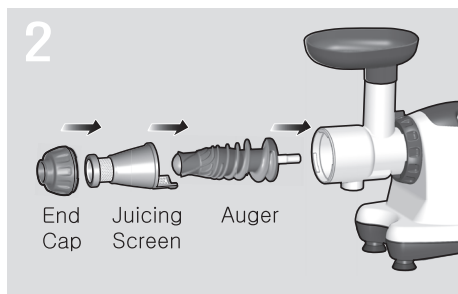

For juicing function, Place the auger into the drum. Insert the juicing screen into the drum. Place the end cap onto the drum end and turn it counter-clockwise until it clicks firmly into place.

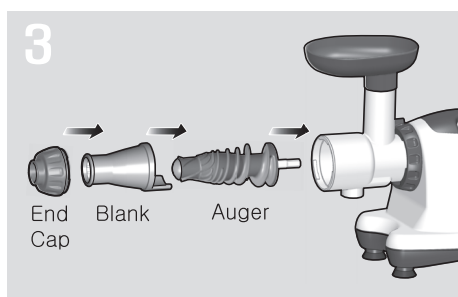

For mincing function, Place the auger into the drum. Insert the blank into the drum. Place the end cap onto the drum end and turn it clockwise until it clicks firmly into place. If interested in making pasta, noodles or breadsticks, please proceed to page 10.

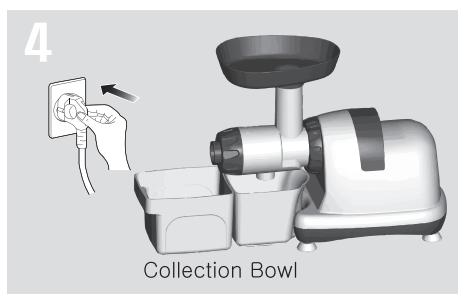

Place juice bowl and waste bowl under drum set. Plug power cord into wall outlet.

## Assembly Instructions

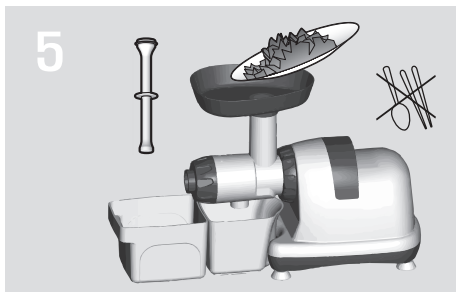

Press the ON button. Place a few pieces of cut fruit or vegetables, one at a time into the guide. Use the plunger to press the fruit or vegetables gently down the guide. Leave the machine on as you feed in the fruits/vegetables.

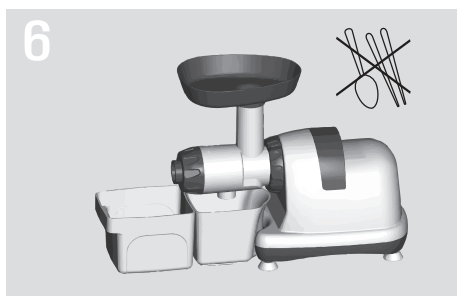

DO NOT place any metal objects into the funnel. If the drum set is clogged or the machine stops operating, press the reverse button 2 to 3 times and press the on button again to resume normal operation.

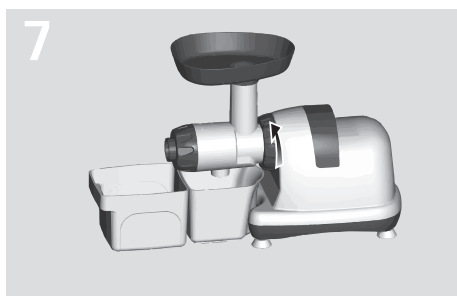

Switch the juicer OFF before changing accessories or touching any moving parts. Remove the drum set from the housing by turning the locking clip counterclockwise. Pull the auger forward to disassemble it from the drum set. After juicing, wash all parts in warm soapy water. Parts may be placed on the top rack of the dishwasher.

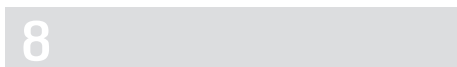

Do NOT run juicer for more than 30 minutes continuously at any one time.

## MAKING PASTA, U-DONG, NOODLE OR BREADSTICK

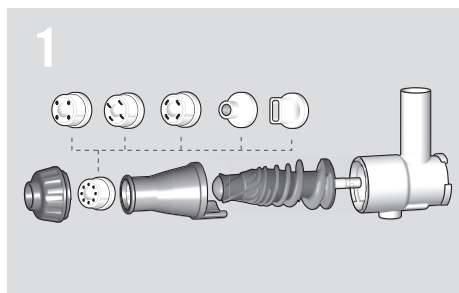

Open end cap.  
Replace juicing screen with blank.  
Choose and place the desired nozzle into the front end of the blank. Turn drum cap counter-clockwise until it clips firmly into place.

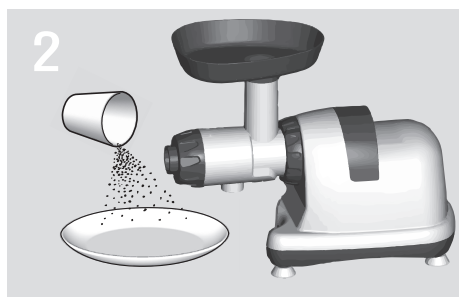

Sprinkle a small amount of wheat flour on the holding dish, placed under the spout.  
Press ON button.  
Push pasta dough through the food guide without stopping.

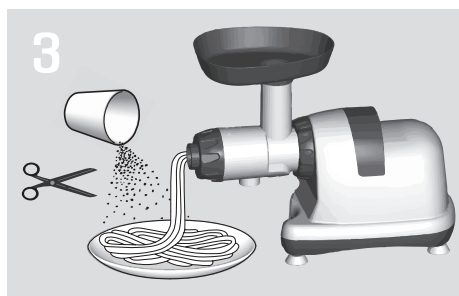

Use scissors to cut the pasta to desired lengths. Cook according to recipe used.

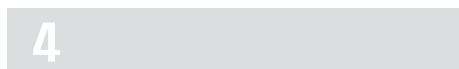

Disassemble unit and rinse all parts and accessories first in cold water. Then wash in warm soapy water in your sink. Parts may be placed on the top rack of the dishwasher.



## Choosing the Right Strainer

Material	Strainer
Apples, oranges, pears, grapes, ginger, tomatoes, kiwi fruit, strawberries, avocados, aloe plant Pine tree leaves, kale, radishes, beet tops, (fruit) spinach, carrots, yams, wheat grass	Juicing Screen
Red/green pepper, garlic, ginger, herbs, soaked rice and beans, fresh fish and meat	Blank
Pasta, Spaghetti, Noodle, Dumpling, Nut butters and homogenizing and (frozen fruits)	Blank

# FRUIT AND VEGETABLE JUICER

**Cone : Juicing Screen**

**Nozzle : No Nozzle Needed**

## HELPFUL HINTS

- The included sieve, which fits on both of the bowls, should be needed after processing items that have more pulp or foam for your taste. It should not be used during the juicing process. It should be used at the end of the juicing process by pouring all of the prepared juice through the sieve.
- While the **Omega 8007/8008 Nutrition System** can extract juice from unpeeled fruits and vegetables, we recommend you thoroughly wash and peel your fresh ingredients to remove accumulated chemicals.
- Cut fruit or vegetables into small pieces so that juice may be extracted more thoroughly.
- Turn on the machine and let it run without interruption until all the juice has been extracted.
- When using a combination of soft and firm produce, alternate the items. It is best to start with the softer items and to finish with the firmer items.
- If the pulp in the drum starts to clog, turn off the machine and empty the drum set. Reassemble and resume normal operation.
- Do not juice anything that will change the taste in a negative way. (Example: orange rind)
- Items that are traditionally thrown away for meals may be juiced. (Example: carrot or beet stems)
- Soft produce will process more easily if refrigerated.
- Items like ginger, lemon and beet may be added for taste. They should all be used according to your taste. Although they are listed in many of our recipes, they are optional. Make drinks that suit your personal taste or health needs.
- After placing the last piece of fruit or vegetable into the funnel, keep the machine running for a few seconds longer to ensure the machine has extracted the last drops of juice.
- Clean all parts that come into contact with juice after each use of the **Omega 8007/8008 Nutrition System**.

## WHEATGRASS AND GREENS JUICER

**Cone : Juicing Screen**

**Nozzle : No Nozzle Needed**

### HELPFUL HINTS

- Small quantities of wheatgrass/greens will be easier to push down the feed chute. Do not overfill the feed chute.
- When juicing items like wheatgrass/greens, some juice may exit into the pulp bowl and not the juice bowl, this is normal. This may occur until the ejection area is filled with pulp.
- Allow most of the juice to exit before pushing the next item in.
- When using a small item or piece of an item for taste, insert that item during the first half of the juicing process. If inserted at the end, the full taste may not come through.
- Various green drinks may be too strong for some people. If so, it is advised to add carrots or beets, which will sweeten or mask the taste of the greens so you may still enjoy its benefits and nutrients.
- The included sieve fits on both of the bowls. It should only be needed when processing items that seem to have too much pulp in the juice or excessive foam on the top of the juice. The sieve should not be on any of the bowls during the juicing process. It should be used at the end of the juicing process by pouring all of the prepared juice through the sieve.

## GROUND COFFEE BEANS

**Cone : Blank**

**Nozzle : No nozzle**

To grind, gather needed quantity of coffee beans. Place the items in the chute at a slow, steady pace. The items will come out finely ground. Do not add too many beans at a time, let the grounds exit before inserting more. There should be no need to run the items through twice. Some coffee beans may have a higher oil content than others, especially gourmet coffee beans. These should be dried out overnight in order to process easier.

## HOMOGENIZING – NUT BUTTERS, FROZEN DESSERTS, ETC.

**Cone : Blank**

**Nozzle : No nozzle necessary, but may be used if desired.**

### HELPFUL HINTS

- Nut butters are an all-natural version of peanut butter.
- Most nuts need additional oil added.
- Remove all skins and shells from nuts.
- Fruits can be cut into pieces and then frozen prior to juicing them.
- Juice can be frozen in ice cube trays and those cubes can be put through the machine.
- You may try to add milk, yogurt, syrups, or sugar to change the taste or consistency.
- Some Nuts/Beans may need soaked overnight.

## MINCING AND CHOPPING

**Cone : Blank**

**Nozzle : Round Hole / Oval Hole**

### HELPFUL HINTS

- The mincing/chopping function can be used in many “food processor” type ways.
- Seed and peel any part of the fruit or vegetable that you do not want in the finished product.
- Remove any fat from meat or poultry if not desired in the finished product.
- Bone and scale fish before processing.
- You can chop or grind meat, fish, fruit, vegetables, herbs, soaked rice and beans.
- Uses include marinades, salsas, soups and sauces.

## PASTA EXTRUSION

**Cone : Blank**

**Nozzle : Desired Nozzle**

### HELPFUL HINTS

- Water may be added if the dough becomes too dry.
- Sprinkle a small amount of flour on the holding dish before making pasta. This will prevent sticking.
- Sprinkle a small amount of flour on the pasta as it piles up. This will prevent sticking.
- Pasta may be cut with scissors or knife to desired length.
- Decide which styles of noodle you would like to make and place the appropriate nozzle on the Omega 8007/8008 Nutrition System. Make the pasta dough into the shape of balls or tubes (slightly smaller than the opening).
- A consistent motion without any gaps will give you longer noodles as the pasta exits.
- The freshly made pasta should be put into boiling water. Fresh pasta cooks faster than packaged pasta. Keep checking in order to remove the pasta at the desired consistency.
- If you would like to get more creative, you can make any flavorful additions you'd like. Spinach, basil, or sundried tomatoes may be added to the pasta dough.
- Leftover vegetable juice or pulp may be mixed into dough for extra flavor.
- The pasta function of the Omega 8007/8008 Nutrition System is to only extrude pasta. The unit is not designed to make pasta. The following recipe can be done by hand or in a mixer.
- If you would like to attempt the full process of making the pasta in the Omega 8007/8008 Nutrition System, try the following: after the ingredients are mixed enough that you now have a ball of dough, run the dough through the Omega 8007/8008 Nutrition System several times to knead the dough. **Do not** use any nozzle when doing this.

## RECIPES

### WHEATGRASS AND GREEN RECIPES

#### **Wheatgrass**

5 or 6 handfuls of wheat grass

Wheatgrass regimens should be started slowly. This natural anti-oxidant can make people nauseous until their body gets used to it. Only an ounce or so is suggested until your body acclimates. Mixing with carrots can soften the taste.

#### **Carrot Parsley**

A handful of parsley

4 or 5 carrots

Insert the parsley first, followed by the carrots.

#### **Wheatgrass Carrot**

Handful of wheatgrass

5 or 6 carrots

Insert the wheatgrass, followed by the carrots.

## HOMOGENIZING RECIPES

### **Nut Butter**

2 or 3 cups of nuts  
Peanut oil (or other nut oil)  
Salt (optional/to taste)

Place small handfuls of nuts in the juicer. Allow the nuts to process before placing the next handful in the chute. Most nuts will need small amounts of oil added at times to keep the moisture level higher. Most nuts will need to be processed multiple times to gain a smoother consistency.

### **Banana - Banana Berry Sorbet**

2 or 3 bananas (peeled)  
6 to 12 berries (no stems or seeds)

Place items in a zip-lock style bag. Place the items in the freezer overnight. It is helpful to cut the bananas into smaller pieces before freezing. Place the frozen pieces into the juicer. The result is an ice cream or frozen yogurt-type dessert. You may run the item through multiple times to increase creaminess.

### **Baby Food**

Fruits and/or vegetables (cleaned, no stems, rinds or seeds)

Place fruits or vegetables into the chute. Most items should be processed twice. Most baby food should be diluted with water due to strength of straight juice. For taste or softness, some items may be cooked prior to processing.

## MINCING AND CHOPPING RECIPES

### **Salsa**

1 1/2 cups tomatoes (seeded)	1 to 2 tbsp. cilantro – to taste (optional)
1/4 cup red onions (peeled)	2 limes
1 tbsp. garlic	Salt (to taste)
1 tbsp. jalapeno	Freshly ground pepper (to taste)

The two limes are needed for the juice only. You may juice them first or squeeze them for the juice. Process the first five items while alternating. If the mixture seems too wet, some juice may be drained. Add the lime juice. Stir. Salt and pepper to taste.



## PASTA EXTRUSION RECIPES

### Pasta Dough

3 cups semolina flour (most flours may be substituted)

3 eggs

1/8 tsp. salt

Water (as needed)

Place the flour on a large, flat surface. Make a bowl or well-type shape in the pile of flour to hold the other ingredients. Beat the eggs. Add the eggs and salt into the bowl of flour. Use fork to slowly incorporate the eggs into the inner layers of flour. Once the eggs become incorporated into the flour, begin kneading. Continue kneading until the dough becomes very firm.

If the dough does not feel dry enough, knead it by hand – adding semolina to the dough as you knead. Start by dusting a non-porous surface with semolina and place the dough on the dusted surface.

Sprinkle some more of the semolina over the top of the dough, then knead the dough until it is smooth and very firm.

When you can set the dough on a clean countertop (without a dusting of flour underneath it) and trust that it won't stick, the dough is ready.

Because of the size of the semolina grain, the dough may not be as smooth as it would be with a flour-based dough.

Wrap the pasta dough into an airtight plastic-wrapped ball. Set dough in a clean, dry area. Let it sit at room temperature for about an hour to give the gluten inside the flour a chance to relax. If the dough isn't given a chance to relax, it will be too stiff to work with and will yield tough noodles.

Once your dough has had a chance to rest, unwrap it and make noodles.







OMEGA PRODUCTS, INC.  
3355 ENTERPRISE AVENUE, SUITE 160  
FORT LAUDERDALE, FL 33331  
PHONE: 877.368.2797  
FAX: 954.202.7337