

# roolen



## BREATH

Smart Ultrasonic Humidifier

## TABLE OF CONTENTS

P0	Table of Contents
P1	Content Of Packageing
P3-4	Parts Identification
P5-P10	Operation and Use
P11-P14	Safty Instruction
P15-P16	Maintenance
P17	Spec
P18	Trouble Shooting
P19	Warranty Information

CONTENT OF PACKAGING



Humidifier  
( water tank )



Basin



Manual

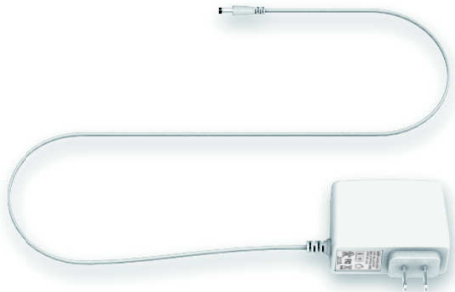

Adapter

## PARTS IDENTIFICATION

### Front

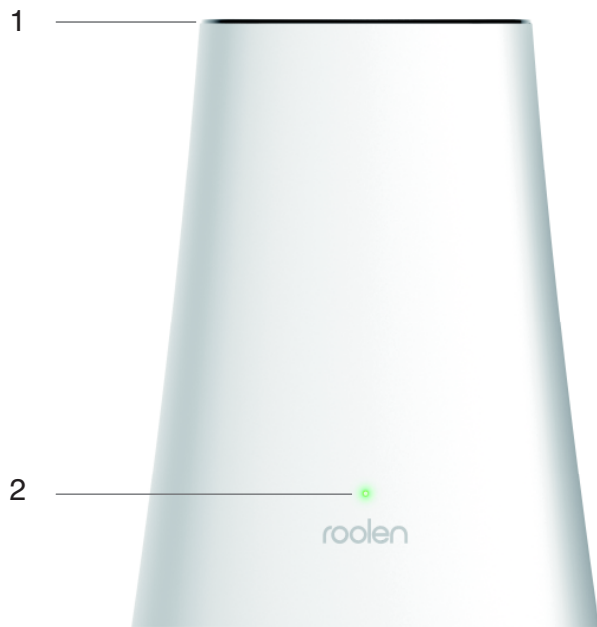

### Back

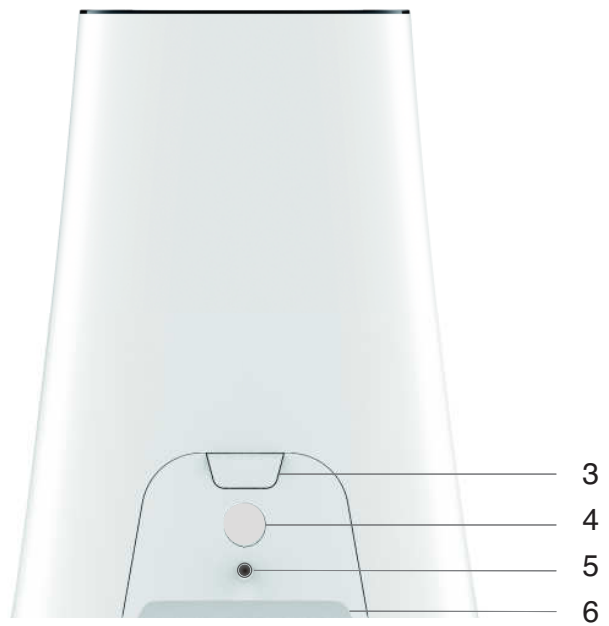

- 1. Top Cap
- 2. Indicator Light
- 3. Detach Button

- 4. Function Button
- 5. Power Plug-in
- 6. Air Vent

## PARTS IDENTIFICATION

### Top



7. Mist Output Slot

### Bottom



8. Product Label

## PARTS IDENTIFICATION

### Basin



- 9. Level Sensor
- 10. Fan Vent
- 11. Transducer

### Tank

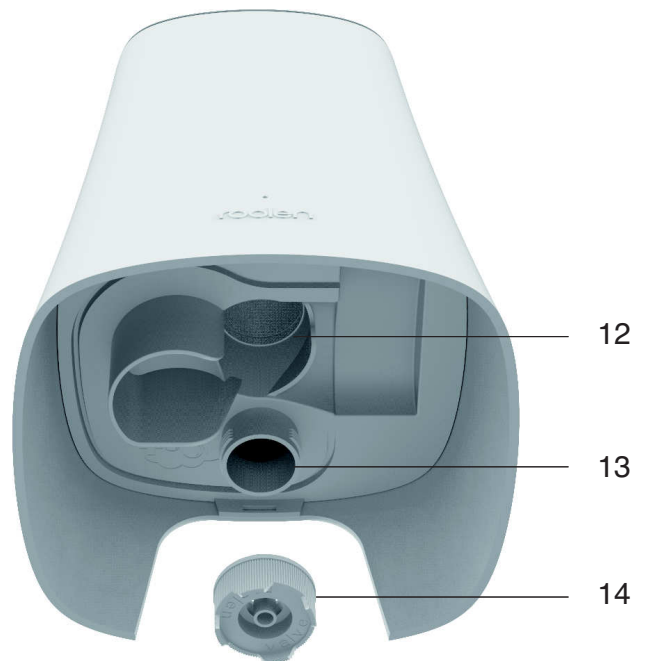

- 12. Mist vent
- 13. Water Tank
- 14. Tank Cap

## OPERATION AND USE

- 1 Push the detach button to separate the water tank and the water basin.



- 2 Unscrew the water tank cap. Make sure the mist vent is not blocked.



- 3 Fill the tank with filtered water. Use the water less than:  $< 50^{\circ}\text{C}$  ( $122^{\circ}\text{F}$ ). Lock the cap back.



- 4 Set the basin where you want the Breath placed and replace the filled water tank. P.7



! Tap water can be used but cleaning of humidifier needs to be done weekly.

! Do not tilt or carry the unit after the water is filled in the basin.

## OPERATION AND USE

5 Connect the power to the humidifier.



6 The indicator light will show orange for "stand by" mode.







7 Press the function button in the back to set the output mode.



8 Choose the output mode you desire.

P.9

-  Stand by
-  Low
-  High
-  Auto
-  Out of water



## OPERATION AND USE

### Placement

Place the Breath using these recommended distances. This will ensure the proper misting into the room.

40 inch +  
100cm +

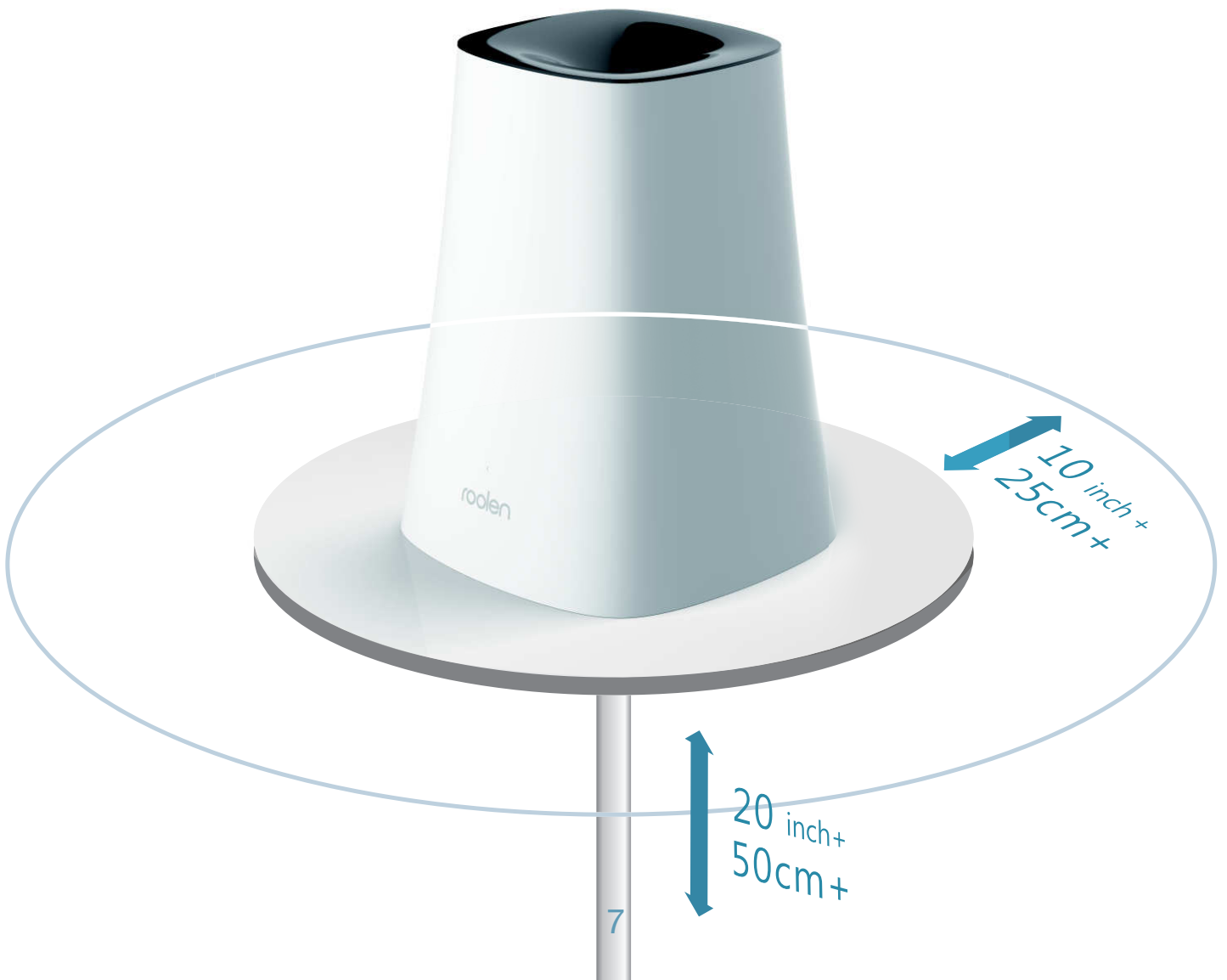

 **WARNING** 

The following types of water cannot be used due to its high mineral content.

- Ground water
- Acidulated water
- Geothermal water
- Mineral water
- Ionized alkaline water

**We suggest you use filtered water when using our product.**

We suggest you use filtered water when using our product.

If it's difficult for you to access filtered water at home. Water from your tap is permitted but would require cleaning the misting device part in weekly basis.

---

**Do not mix with anything**

Do not mix the water with any other substance such as lotion, oils or scents , etc.

Doing so, may cause short-circuits, malfunctions, or shorten the life of the transducer.

## OPERATION AND USE

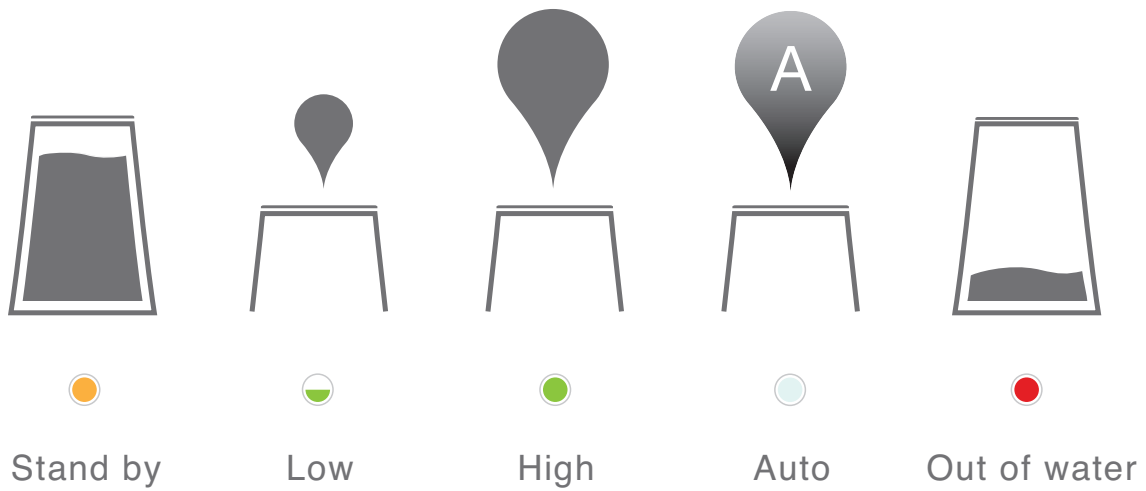

## INDICATOR LIGHTS OPERATION

Forget about complicated control panels, Select the Mode you like with the function button on the back to experience the perfect balance in your home.

# HOW AUTO MODE WORKS

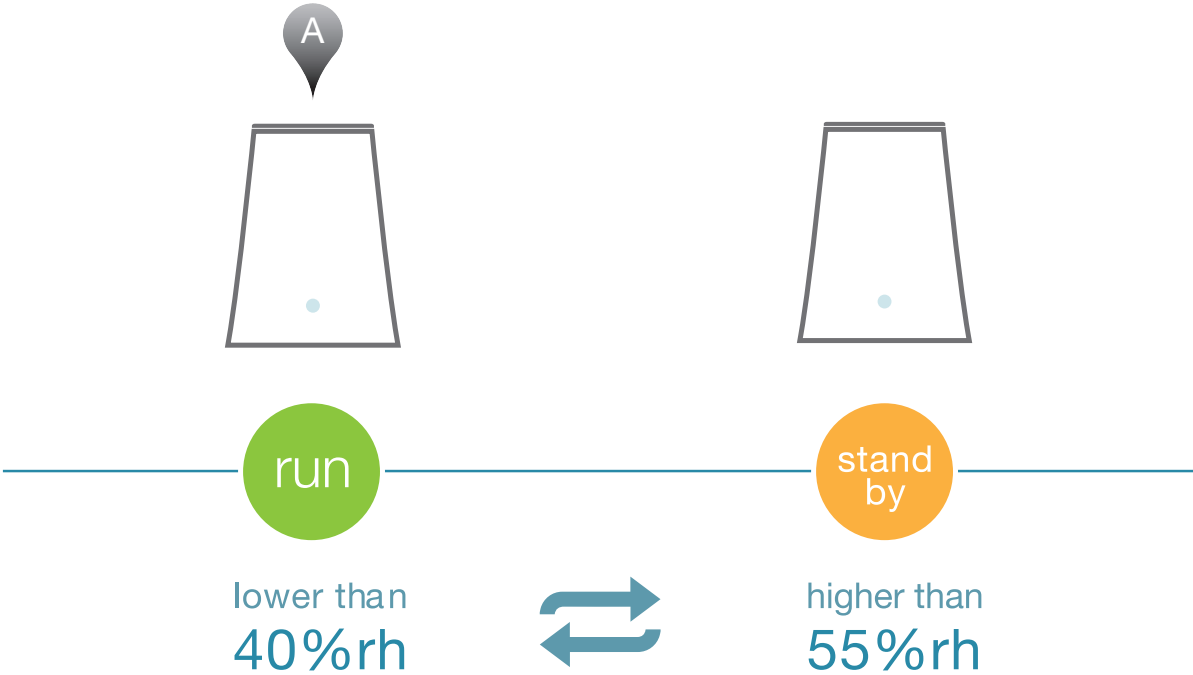

If no mist is being emitted on auto mode, it means the humidity in the room is already balanced between 40-55% rh

## SAFTY INSTRUCTION

### **PLEASE READ ALL THE SAFTY INSTRUCTIONS BEFORE USING HUMIDIFIER**

Please comply with all instructions to avoid serious injuries. It must be understood that the instruction manual cannot cover all possible conditions that may occur.

---

1. Check the product for any possible damages before using the humidifier. Extend the cord and inspect for any defects. Do not use the product if the cord is damaged.
2. Keep the humidifier on a solid, flat, surface.
3. Keep the humidifier away from items and furnishings that can be damaged by water (wooden furniture, wallpaper, etc.)
4. Place humidifier in an area that is out of reach from children.
5. Keep unit and cord away from heated materials.
6. Do not operate outdoors; this appliance is intended for indoor use only.
7. Do not operate without water. Turn off unit when tank is empty.
8. Do not immerse the base in water or in other liquids.
9. Do not add any chemicals or fragrance oils into the water tank.

## SAFTY INSTRUCTION

10. The humidifier should always be unplugged and emptied when not in operation or while being cleaned.
11. The humidifier should not be left unattended in a closed room since air could become saturated and water vapor will condense on walls or furniture. Leave room door partly open. Do not aim vapor opening directly at children, walls or furniture.
12. Caution: To avoid the risk of fire, shock or personal injuries, do not use an extension cord.
13. The humidifier requires regular cleaning. Do not use detergent to clean the unit. Please refer to and follow cleaning instructions.
14. The automatic shut-off safety sensor works when there is not enough water in the tank or if the tank is separated from the bottom of the humidifier.
15. Do not move or tilt humidifier while it is operating.
16. Filtered or distilled water is recommended to avoid white dust.
17. This appliance is not intended for use by persons with reduced physical, sensory or mental capabilities, or lack of experience and knowledge, unless they are under supervision or given instructions concerning the use of appliance by a person responsible for their safety.

## SAFTY INSTRUCTION

18. Children should be supervised to ensure that they do not play with the appliance.
19. Plug and unplug with dry hands.
20. To avoid any accident, never put a hand over the vapor output slot and never cover or use objects to cover any openings when the unit is operating.
21. Do not unplug from the wall socket by pulling on the supply cord.
22. Do not use hot water to fill the appliance, otherwise the ultrasonic piece will be damaged.

 CAUTION 



Do Not mix the water with any substance besides water, this may cause malfunctions or weaken the life of transducer.



Do not place the unit on carpet, especially carpet with long fibers or strands. This may block the air vent of humidifier, place it on a flat level surface.



The best humidity level for human is approximately 40-55%(percent) of relative humidity.



Too much humidity may damage the furniture, walls and carpeting allowing fungi and bacteria to grow.

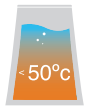

Use the water less than, < 50°C or (122° F).



DO NOT immerse the base in water. When cleaning, please make sure base does not get submerged in water or gets wet.



It may fog or develop condensation due to excessive indoor humidity. To prevent this situation, switch to low mode to reduce the humidity or set to Auto mode where you will have the best humidity level for your room.



## MAINTENANCE

### Daily Maintenance

- 1 Empty water basin when humidifier is not in use.



- 2 Unscrew the tank cap and empty water tank.



- 3 Dry the water basin and water tank with soft clean cloth.



- 4 Replace the water tank. The humidifier is now ready to use.



## Weekly Maintenance

1. Unplug the power cable.
2. Remove the water tank from the base and empty the water from both the tank and water basin.
3. Fill the tank with 2 cups of water and 1/4 cup of white vinegar. Shake vigorously and let it sit for 20 minutes. Shake vigorously again and empty the tank. Rinse the water tank a few times to rid any vinegar smell. Wipe with clean soft cloth.
4. Do not pour water into the fan vent. Make sure nothing is blocking the fan vent.
5. Wipe the exterior surface of the water tank and basin with clean soft cloth. Never immerse water basin in water.

## End of Season Maintenance

1. Detach the water tank from basin and empty the water from both the tank and the water basin.
2. Sanitize water tank and water basin with white vinegar and water solution.
3. Make sure that the water tank is completely dry without the cap secured.
4. Store the humidifier in a cool dry place.

## SPEC



Rating Voltage	100-240v
Frequency	50/60hz
Power	20W
Available Colors	Black, White
Low / High / Auto Mode Run Time	24 hrs / 12 hrs / 24+ hrs
Humidifying Capacity	Up to 400sq.ft / 28m2
Noise	< 25db
Water Tank Capacity	3.15L / 0.83 Gallons
Weight	1.1KG / 2.4 Lbs.
Dimensions	20 x 20 x 26cm / 7.9" x 7.9" x 10.2"inch

## TROUBLE SHOOTING

Problem	Solution
<b>Humidifier Ceases to Function</b>	<ul style="list-style-type: none"><li>• Ensure that the level sensor is assembled properly</li></ul>
<b>Unpleasant Odor</b>	<ul style="list-style-type: none"><li>• Clean the water tank with water and vinegar and rinse it with clean water.</li><li>• Leave the tank open for some time without the cap on in a cool dry place.</li></ul>
<b>Lights On but No Mist Being Emitted</b>	<ul style="list-style-type: none"><li>• Make sure that nothing is blocking the fan vent.</li><li>• Check the mist out put slot.</li></ul>
<b>Presence of Dust</b>	<ul style="list-style-type: none"><li>• Tap water may contain too many minerals, use of purified water is recommended.</li></ul>
<b>Presence of Fog or Condensation</b>	<ul style="list-style-type: none"><li>• Reduce the humidity of the room by leaving the door open and switching the output mode to auto (dim green light).</li></ul>

## WARRANTY

### LIMITED WARRANTY

This product is warranted to be free from manufacturing defects under normal use and conditions for 1 year.

The warranty will be invalid if the unit is damaged by accident, improper repair or failure to follow safety instructions provided with the product. This warranty does not apply to normal wear and tear or commercial use.

You can't transfer the warranty to subsequent owners of the product. Liability under this warranty is limited to repair or replacement. In no event shall liability exceed the purchase price paid by the purchaser of the product. Under no circumstances shall there be liability for any loss - direct, indirect or incidental – or consequential damage arising out of, or in connection with the use of this product.

For the most up-to-date warranty information and instruction, please visit our website.

[www.roolen.co](http://www.roolen.co)

# roolen



If you have any questions regarding to the operation of this humidifier, first refer to the troubleshooting page. For further information, visit our website or contact us via Email.

**[service@roolen.co](mailto:service@roolen.co)**